

Installation instructions for capped deck boards

Your guide to installing our Evolution collection.



Before you start

Safety information

Read and understand this entire manual before you begin the installation of your decking.

Static electricity notice

Dry or windy environments may create a temporary condition of static electricity in many plastic-based products such as carpeting, upholstery, and composite and PVC decking, which will vary depending on climate and site conditions. Static electricity is a naturally occurring phenomenon and is not a defect. In the case of excessive static build-up on an installed deck, Ecodek recommends the following:

1. Remove loose debris from the deck surface.
2. Dilute ACL Staticide® Concentrate as directed on the bottle. Dowsing with water will remove the charge but will not guard against static build up over time on its own.
3. Spray or mop the entire surface of the deck. Allow to air dry. Do not attempt to wipe the surface dry as wiping will reduce the effectiveness of the anti-static coating.

Caution:
Although very safe in diluted form, ACL Staticide Concentrate is considered a hazardous chemical non-diluted. DO NOT use ACL Staticide Concentrate non-diluted.

Warning:
Use extreme caution when using power tools.

Warning:
This decking is for deck surfaces and deck-related surfaces, such as stair treads or ramps, only. Material is not approved for structural applications.

Warning:
When using a ladder on composite decking, it is mandatory to lay down a sheet of plywood over the deck surface to disperse the load of the ladder's feet to nearby underlying joists. Drill fasteners downward through the top of the plywood sheet to keep it from slipping. Position fasteners so they adequately protrude and rest firmly in the gaps between the deck boards and into the joists. This will avoid leaving holes in your decking once the plywood sheet is removed. Always follow the ladder manufacturer's instructions and safety tips.

Caution:
Unusual sources of heat and heat build-up can potentially damage decking surfaces. Examples include fire pits, reflected light from nearby windows and doors, and under-deck waterproofing installations that do not provide adequate ventilation. Exercise caution if walking barefoot on the deck while it is in full sun.

Caution:
Fasteners have sharp edges. Use proper care when handling.

Tools for the job

No specialist tools are required to install Ecodek, however we would recommend the following which will help you fit your perfect deck.



Circular saw



Cordless drill



Spirit level



Smart bit



Chalk line



Ecodek spacer



Safety glasses



Hearing protection



Dust mask

Pre-installation

Important:

Follow local applicable building regulations. Careful planning of the finished deck layout will result in more pleasing finished projects. Failure to follow installation guidelines could void the warranty.

Acclimatisation and storage

Before installation, material should be stored on a flat surface, supported every 600mm, and in the shade or covered if original packaging is removed.

Air flow and drainage

Make sure there is adequate and unobstructed air flow under the decking. The minimum height build-up of the deck including deck board is 105mm. Allow a minimum of 10mm between the bottom of the joists and the ground or existing surface. Water must be able to flow away from under the deck. Improve drainage or grade flat areas where standing water may gather. Do not install decking directly to an existing or solid surface.

Determining joist location

Joist location is important for the safety of the deck and will affect the layout, cost and ease of installation for the balustrade system. If using balustrade, determine rail post placement prior to joist construction.

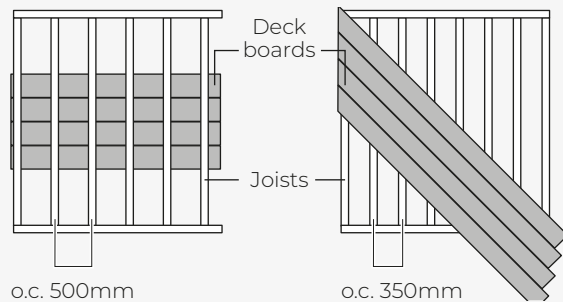

Joist / stringer spacing

Residential

Perpendicular	Diagonal (up to 45° angle)
500mm	350mm

Expansion and spacing considerations

All decking materials, whether wood, composite or metal, undergo some degree of linear expansion with the change of weather and the seasons. For best spacing results, keep boards out of direct sun during storage and cutting processes and throughout installation, if possible. To compensate for the effects of contraction and expansion, use short boards (where possible) with splitter / divider boards between each continuous run of boards.

Adequate board spacing of a minimum 5mm between board sides will provide proper drainage and assist with the removal of small organic debris. Allow a minimum of 10mm spacing between boards and any permanent structure.

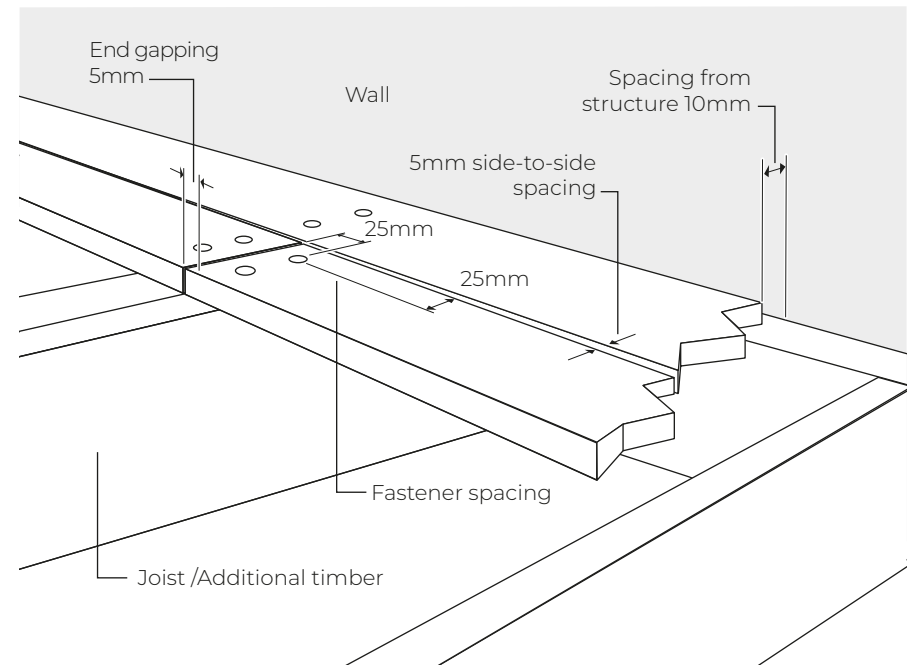

Noggin installation

When installing additional noggins, remember that noggins laid flat will inhibit water flow and result in the build-up of organic materials over time, which will make cleaning more difficult and can cause eventual damage to the material.

When noggins are required, install ladder style for best results.

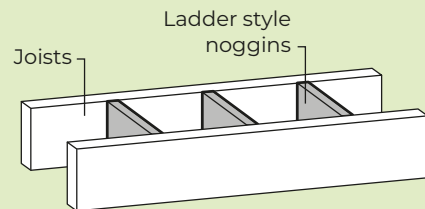

Heavy loads

Please contact our technical team.

Before laying your first board

Familiarise yourself with the wood grain pattern on the boards. Please ensure that every time you lay a board, the wood grain pattern is running in the same direction.

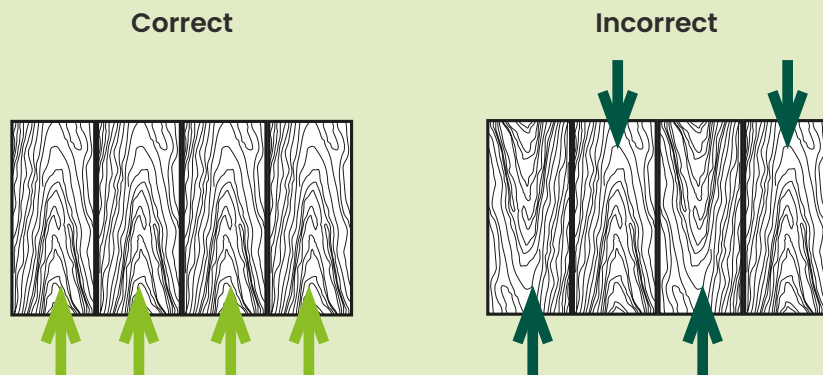

First and final end board installation

Installing the first end boards

- Ecodek recommends starting on the outside of the deck and working toward the house / wall. This way, if any board needs cutting down to fit, the cut side will be against the house / wall.
- If starting at the house / wall, secure screws through the top of the board with a single screw.
- Space screws no more than 500mm apart.
- Pre drill the boards for the screws as necessary.

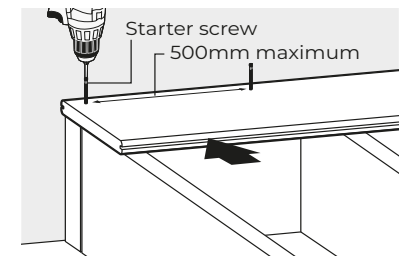

Follow instructions for Ecodek WEDGECLIP™ (pg. 8 -9) or universal fasteners (pg. 10 - 11) to install the mid-deck area, before following instructions to install the end boards.

Installing the final end boards

Note:

Use a square-edge board to create a smooth, finished look along the perimeter of the deck.

- After positioning the last deck board in place, secure the deck board by driving a screw into the board at a 90-degree angle.
- Ensure the screw inserts fully and pulls the board down. Space no more than 500mm apart.

Installation using WEDGECLIP™ fasteners

Preparing the grooved board edges

- After installing the first end boards (pg. 7), position WEDGECLIP™ hidden fasteners along the deck board, centring on joists.
- Pinch the wings of the clip together and slide it into the groove.
- The clips are designed to stay in place until you're ready to fasten.

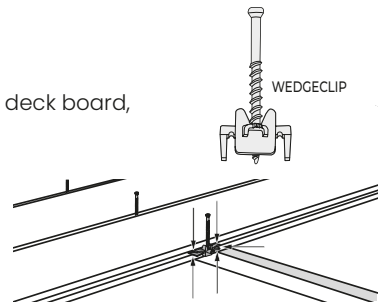

Note:

Grooved boards are not intended to be used as perimeter boards unless you are also installing fascia boards appropriately to cover the exposed grooves, or when the groove is against a wall or other hard structure.

Installing the remaining boards / rows

- Place the next board up against the clips.

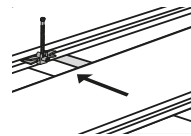

Securing the boards

- Ensure correct end-to-end gapping and hold the boards tightly while securing or lock them in place with CAMO LEVER® (sold separately).
- Screw down all of the clips between the boards. Use NEVER-MISS™ Guide for fast manual installation, or DRIVE™ tool (optional) to fasten while standing up.
- Repeat installing fasteners and positioning boards to cover the deck surface. See "Installing the final end boards" (pg. 7) for completing the deck.

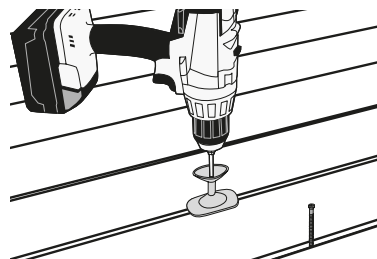

Fastener butt-joint installation

- Where two boards butt together, allow for adequate end-to-end board.*
- Centre the end gap over the joist and use four WEDGECLIP™ clips (two on each side of the board ends) to secure them.
- With boards positioned correctly, place the clips in the groove, centred on joists on both sides of the boards.
- Partially fasten the screws to hold them in place until next board is set, then fully fasten the screws.

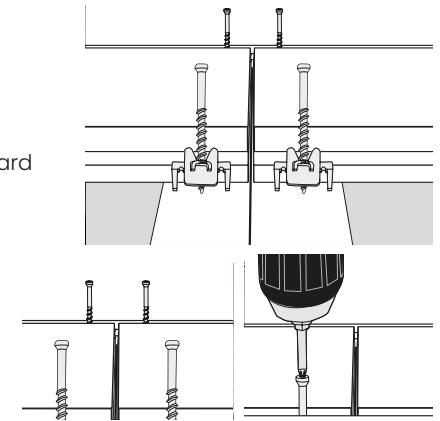

*Where two boards butt together, allow for a 5mm gap between the boards.

Replacing damaged boards with WEDGECLIP™ clips

Back out screws from joist

- Back all of the WEDGECLIP™ screws out of the joist on both sides of the full length of the board.

Replace board

- Pull up on the board to remove it.
- Clean away any remaining fasteners on the joists and lay the new deck board in position without any fasteners in place.

Remove fastener legs or wings

- Count the number of fasteners needed and snap off the WEDGECLIP™ wings on each fastener.

Securing the board

- Slide the fasteners (screws and gussets) down the groove positioning one over each joist on both sides of the board.
- Ensure there is correct end-to-end gap spacing.
- Fasten clips securely in place using the NEVER-MISS™ Guide

Universal hidden fastener installation for grooved-edge boards only

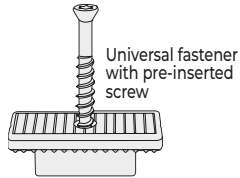

Note:
The universal fastener provides a 5mm side-to-side gap between each deck board

Preparing the grooved board edges

- After installing the first end boards (pg. 7), insert the universal clip into the grooved edge of the deck board in alignment with the centre of each joist. The screws are pre-inserted for your convenience.

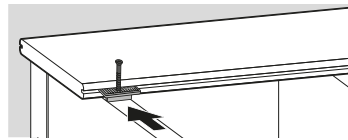

Note:

Grooved boards are not intended to be used as perimeter boards unless you are also installing fascia boards appropriately to cover the exposed grooves, or when the groove is against a wall or other hard structure.

Securing the fasteners

- Using the included T-15 Star drive bit, drive the screw vertically down, not angled, until it is flush in the countersunk hole.
- With some deck boards it may be necessary to leave the screw loose until the next course of decking is laid; then, tighten the screw completely.
- Be careful not to overtighten the screw to prevent breakage or bowing of the clip. A screw gun with a clutch setting is very effective for this application.

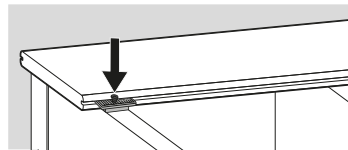

Installing the remaining boards / rows

- Slide the second deck board into place and push or tap forward to ensure the board is flush against the universal deck clip. If left loose, finish driving the screw vertically down, not angled, until it is flush in the countersunk hole.
- Install the remaining clips where each joist intersects with the deck board.
- Repeat installing fasteners and positioning boards to cover the deck surface. See "Installing the final end boards" (pg. 7) for completing the deck.

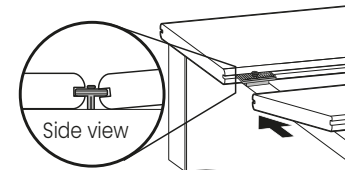

Installing butt joints

- Where two boards butt together, allow for adequate end-to-end board spacing and use a single universal hidden fastener to secure board ends.

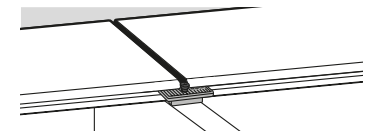

Replacing damaged boards with universal fasteners

Loosen clips from joist

- Loosen the clips holding the damaged board until the board can slide freely.

Remove the damaged board

- Slide out the damaged board from the deck floor.

Note:
If the deck surface has a picture frame and you are unable to slide out the damaged board, it may be necessary to remove the framing deck boards to access the damaged board appropriately to cover the exposed grooves, or when the groove is against a wall or other hard structure.

Insert new deck board

- Clean away any remaining debris on the joists, align the fasteners with the grooves and slide the replacement board into the deck floor.

Secure the new board

- Ensure there is correct end-to-end gap spacing.
- Retighten the fastener screws securely into the joist.



Face-fastener installation

Fastener installation

Always drive face fasteners in at a 90-degree angle to the decking surface with two fasteners at every joist location. Do not angle screws into the joist. Instead, place additional joists to allow perpendicular installation of face fasteners at board ends. Spacing parallel joists apart at butt joints also aids in drainage around board ends.

Deck fastening requirements

Ecodek Evolution decking may be face fastened. Only use Ecodek approved screws.

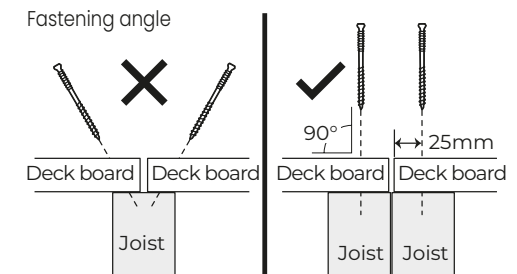

For best results

- Screw heads must be flush with board surface.
- Pre-drilling is required for end-of-board screw holes in cold climates to prevent immediate or eventual end splitting. It is recommended for surface screw fasteners. Pre-drilling all holes will result in more pleasing finished projects.
- Use caution to avoid over-tightening fasteners, or this may induce cracking at board ends and could lead to eventual cracking around other fasteners.
- Straight rows of fasteners look cleaner and less noticeable than uneven rows. White chalk, straight boards or string lines can be used as guides for installing fasteners. Never use colored chalk.

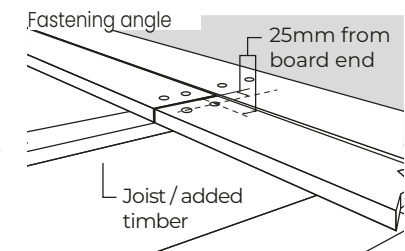
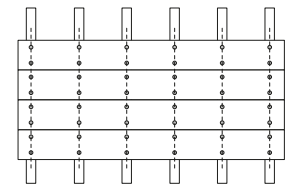

Face-fastener installation

Pre-drilling fastener holes

- For Ecodek Evolution decking, locate all fastener holes at least 25mm from board ends and 25mm from sides.
- To prevent cracking at fastener locations, pre-drill all holes with our Ecodek Her SmartBit or a 3 or 4mm drill bit.
- Keep the drill perpendicular to the deck surface in order to create the proper pilot hole and remove excess material.

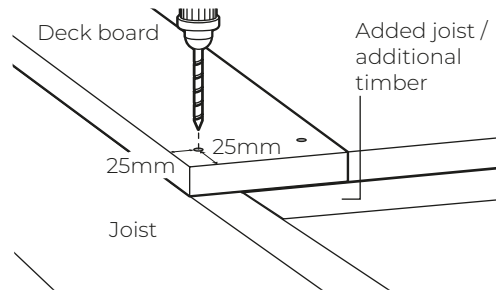

Note:

For best pre-drilling results, use a corded or battery power, variable speed or high-torque drill. Starting screws slowly will help initial engagement. Always keep continuous pressure downward while driving screws.

Installing the fasteners

- Using the drill bit, drive the screw to ensure it is flush or slightly below the face of the deckboard.
- Two screws must be used on every joist.

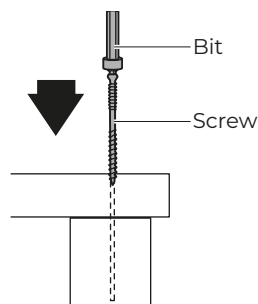

Note:

Replace a worn driver bit with a fresh bit periodically. We recommend replacement every 125 screws.

Note:

If damage occurs to the screw while it is being driven in, do not continue.

Fascia Installation

Ecodek Evolution fascia installation

- Fascia is fastened with screws at a maximum of 300mm intervals, with two screws across the face.
- Always drive face fasteners in at a 90 degree angle to the board surface no closer than 25mm from ends and sides of board.
- Pre-drill ends of board screw holes to prevent immediate or eventual end splitting.
- Install with 5mm spacing between ends.

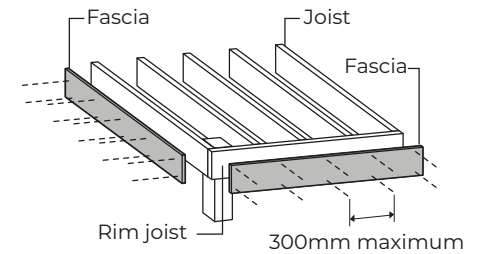

For more details

 01978 667840

 enquiries@ecodek.co.uk

 ecodek.co.uk

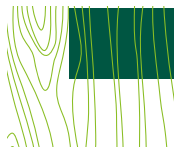

Making outdoors, yours

