



ecodek® Installation Instructions

These instructions are designed as a quick and simple guide to using ecodek®, please ensure that you have also read and understood the *Technical Data* (available to download from our website) in full before commencing any construction projects.

Substructure:

Normally C16 or C24 grade 6" x 2" treated softwood.

Maximum Joist Spacing (centre to centre):

Residential use: Must not exceed 455mm (330mm if at 45° angle). Please refer to the *Load Span Table* available on the website

Airflow Requirements:

Always allow for adequate ventilation under the deck, use larger gaps and air vents if the deck is to be sunken or enclosed (contact us for more detail).

Board Spacing:

Minimum 5mm (increase this to 10mm for hot, humid, damp or poorly ventilated areas).

Butt Joint Gaps:

5mm in between boards and where a board meets a wall. If area is often hot, humid, damp or poorly ventilated, a 10mm gap to the wall must be left.

Fixing Method:

Only use ecodek® approved stainless steel composite deck screws. Screw holes must be countersunk with a Smart-Bit® (available from Ecodek).

Fit decking over at least 3 joists with 2 screws at every joist point and decking must be screwed down 20-40mm in from the cut end of the board.

DO NOT:

- Lay the boards directly onto a non self-draining surface without consulting with our technical department first.
- Use hidden fixings or clips.
- Butt boards up end to end closer than the specified amount.

Drill & Countersink:

Ecodek can supply a Smart-Bit® that will pre-drill and countersink in one quick operation, designed specifically for composite decking.

Fascia Boards:

When attaching fascia boards to the side of a deck, it is important to make sure they are screwed down every 200mm (with 2 screws) along their length. Please allow the same spacing between fascia boards as for decking boards - both for board spacing and butt joint gaps.

Using ecodek® Heavy Duty Posts:

If you intend to use the ecodek® Heavy Duty Post at any length over 1.4m, then you must use a 2" scaffold pole down the centre to reinforce it (pole must come up to within 500mm of the top of the post).

ecodek® Post Caps:

These are designed to be a push fit but the legs can be trimmed to suit if necessary.

ecodek® Installation Instructions - Fixing Detail

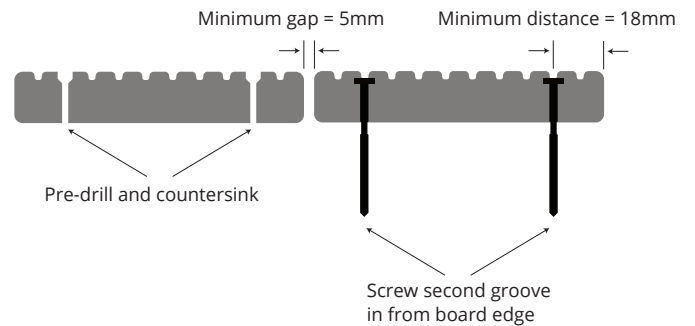
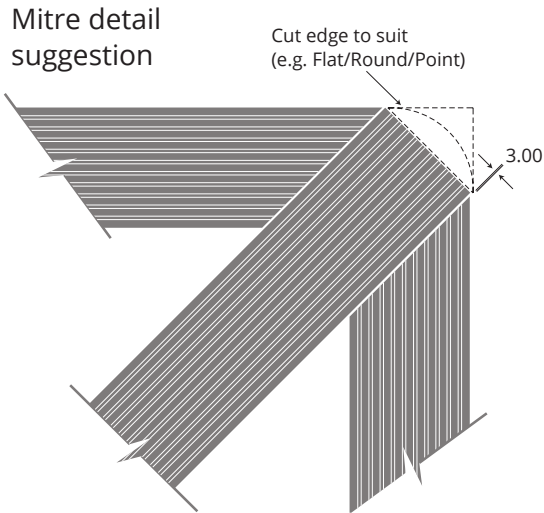
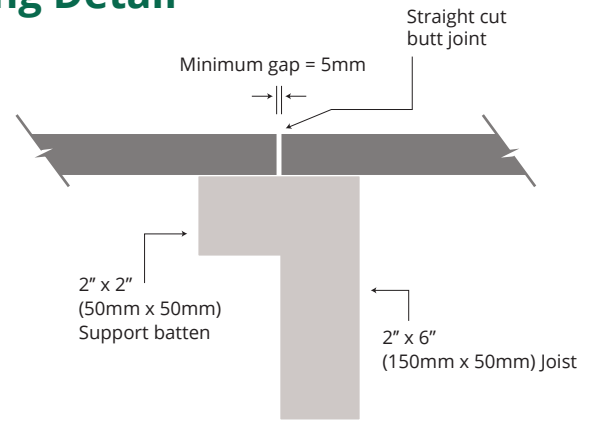
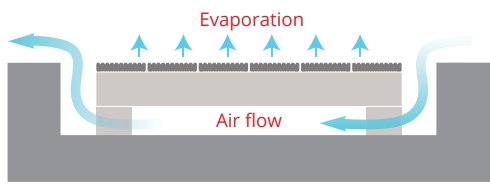

Screw Fitting Instruction

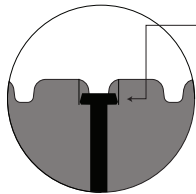

Method of fitment:

- Timber substructure (63mm Screws):**
 Pre-drill deck board with Smart-Bit®.
- Composite substructure (53mm Screws):**
 Pre-drill with a 3.5mm dia bit the full depth of the screw
- Steel substructure (38mm Screws):**
 Pre-drill with a 3mm dia HSS bit, Pilot holes to be drilled second groove in from edges of board
- Remove swarf residue (a 2-3mm slice of deck board snapped in half to give a rough edge makes a good swarf removal tool)
- Preferably use an impact driver as this prevents over-screwing
- Screw head will not go flush with the bottom of the groove but it must not protrude above the deck surface, see the picture for detail

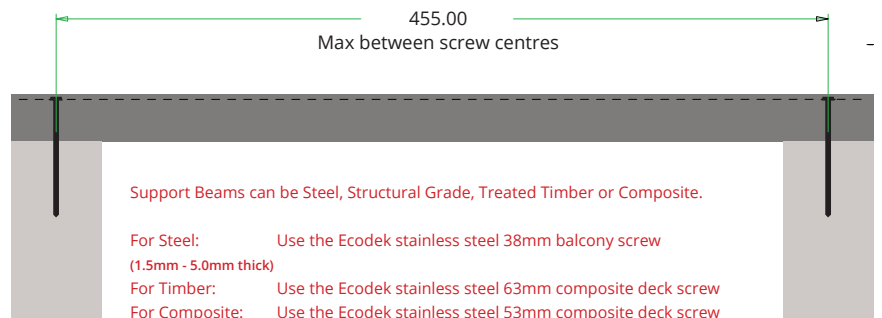
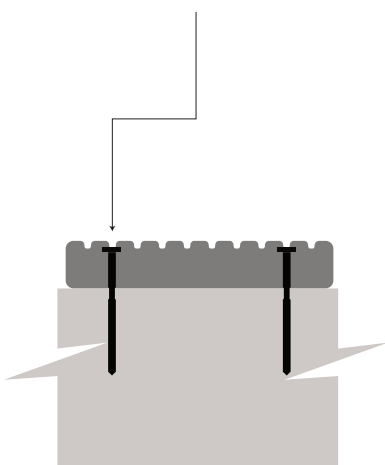

ECODEK® 'AT' 21MM GROOVED/RIBBED DECK BOARD STRENGTH CHARACTERISTICS, AND SPAN TABLE CAN BE FOUND ON OUR WEBSITE

SUPPORT SPACING IS BASED UPON SPECIFIED LOADINGS FOR RESIDENTIAL DECKS, BALCONIES AND WALKWAYS AS PER BS EN 1991-1-1:2002 'ACTIONS ON STRUCTURES - IMPOSED LOAD FOR BUILDINGS'